

Ellipse Jig with Vacuum Base

For use with handheld routers

Version 2.0

Safety First



Disconnect saw from power source before fitting or removing insert.



Always wear proper ear protection when working with machinery.



Use caution when handling sharp objects (saw blades, router bits, drill bits and so on). Use protective gloves whenever possible.



Always wear proper eye protection when working with machinery and tools.



Always wear proper respiratory protection when working near airborne dust particles.

Please read and fully understand any and all safety materials that came with your power tools or machinery before operation. Always follow all safety guidelines set in place by the power tool or machine manufacturer.



Ellipse Jig with Vacuum Base

Exploded Parts View

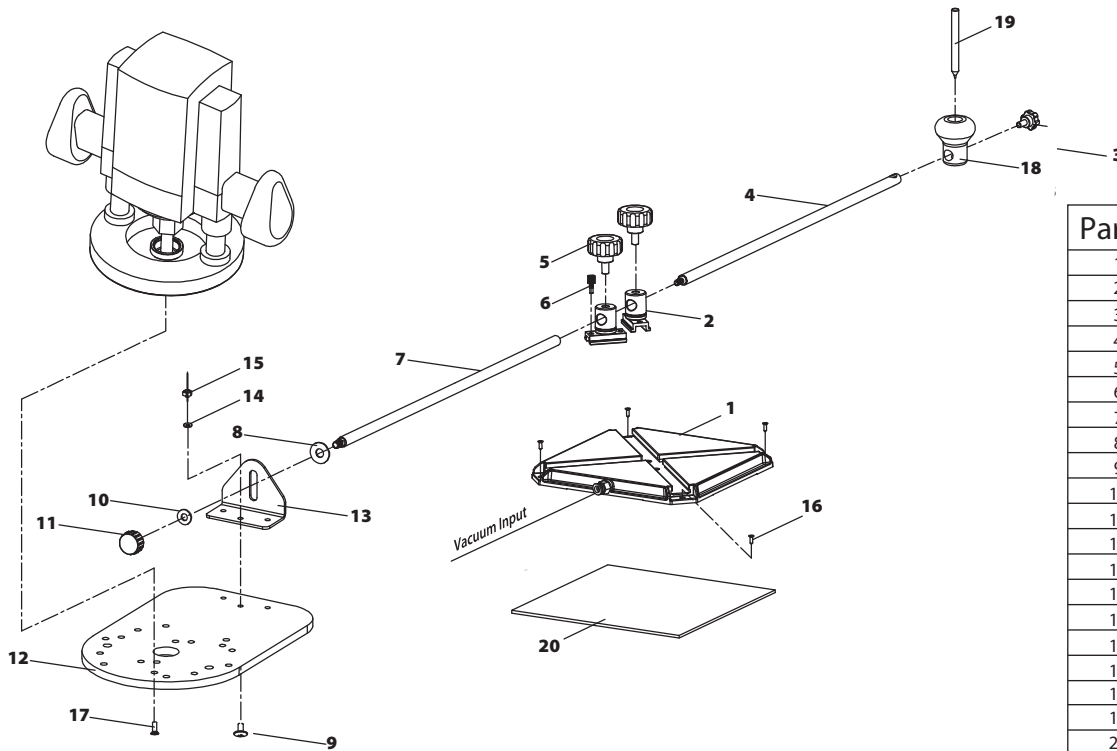

Part #	Description	Qty
1	Ellipse Jig Base	1
2	Steel Rod Guide	2
3	Knob M6 x 12mm	1
4	Steel Rod	1
5	Lock Knob M8 x 20mm	2
6	Thumb Screw M5	2
7	Steel Rod	1
8	3/8" Washer	1
9	Screw M5 x 10mm	3
10	5/16" Washer	1
11	Knob M8	1
12	Router Base Plate	1
13	Steel Rod Bracket	1
14	3/16" Washer	3
15	Nut M5	3
16	Wood Screw 1/8" x 1/2"	4
17	Existing Router Base Screws	
18	Pencil Holder / Handle	1
19	Pencil	1
20	Vacuum Pad	1

1. Initial Assembly

Base Plate Assembly

Prior to setting up the Ellipse Jig for use, some partial assembly is required. Attach the Steel Rod Bracket (13) to the Router Base Plate (12) by aligning the holes on the bracket to the three holes on the base plate. Secure with the three screws (9), washers (14) and nuts (15).

Mount Your Router to the Router Base Plate

Before mounting your router, you must remove the original base plate from your router. Once the original base plate is removed, place your router onto the Router Base Plate (12). Check to see if your router hole patterns align with the predrilled holes on the Router Base Plate.

Please Note: If your holes do not align with any of the holes on the router base plate, you will need to center your router to the Router Base Plate (12) and drill and countersink new holes on the Router Base Plate (12).

Once your router is aligned with the hole pattern on the Router Base Plate (12), secure your router to the Router Base Plate (12) with your existing screws. You may need to replace your existing screws (17) with longer screws (not included) in order to properly mount your router to the base.

Steel Rod Guide Assembly

Thread the Steel Rod Lock Knob (5) onto the Slide Rod Guide Assembly (2). Do not thread on all the way as the Steel Rod must be able to easily fit through the assembly hole.

Please Note: Some of the parts and pieces described in these instructions may already be assembled

Steel Rod Assembly

Secure the Steel Rod (7) to the Steel Rod Bracket (13) and Router Base Plate (12) using the threaded Knob (11), 5/16" Washer (10) and the 3/8" Washer (8). Refer to the exploded drawing above for washer placement.

Pencil Holder (Compass) Assembly

Slide the Pencil Holder/Handle (18) over the end of the Steel Rod (4) and align it with the hole on the end of the rod. Insert the pencil (19) so it fits through both the Pencil Holder/Handle and the Steel Rod. Secure with the threaded Knob (3).

Please Note: It may be necessary to dis-assemble some parts in order to perform specific tasks described in these instructions.

2. Layout your Ellipse



Before using the jig, layout the desired length and width of your ellipse. Generally, this is done on the bottom (underside) of your workpiece.

Please Note: The maximum distance between the major and minor axes is 9"

3. Determine the Centerpoint

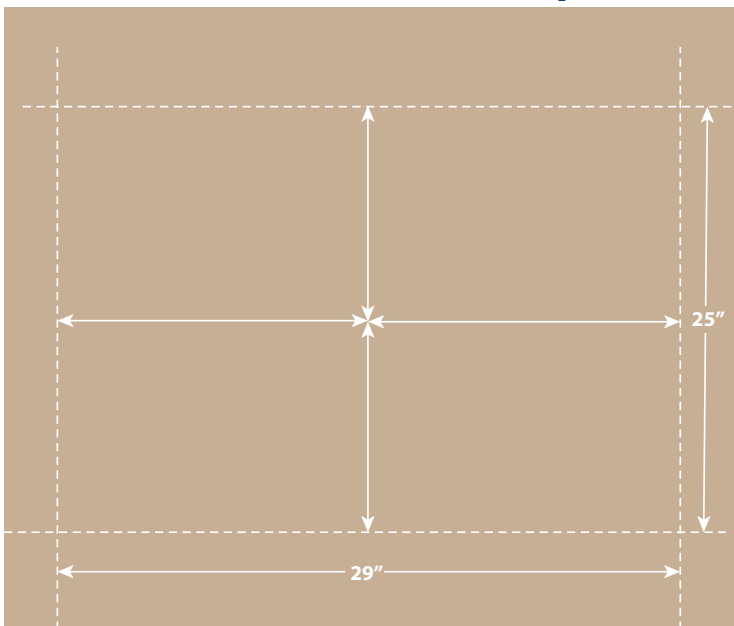

To determine the exact center of your ellipse, divide the length in half, then divide the width in half. Measure from one side and from the top or bottom and make a mark in the center of your workpiece at this point. To make aligning the base easier, draw a horizontal and vertical line intersecting at the center mark that was just made.

4. Align, Center and Secure Base

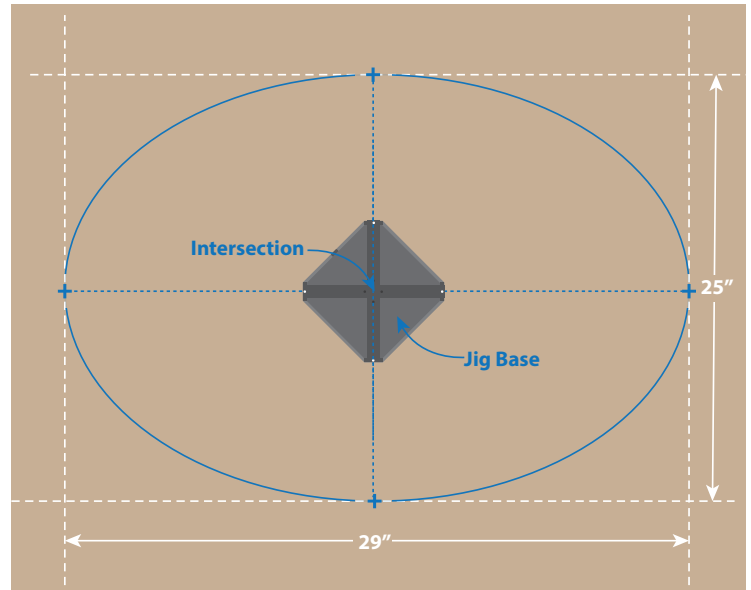

Place the Ellipse Jig Base (1) on the center point marked in step 3. Align the slots with the lines that were drawn in step 3. You may also use the holes at the end of each slot to act as a guide. Secure the base using four wood screws. If you choose to use a vacuum system to hold the base in place, be sure to place the included mat underneath the base.

Please Note: Vacuum system is NOT included and is sold separately.

5. Insert Slide Rod Guides

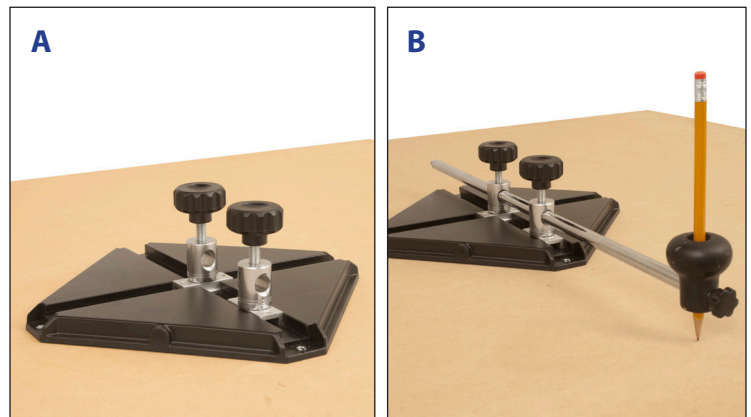

Slide a Steel Guide Rod Assembly (2) into the vertical slot on the Ellipse Jig Base (1) and the other Steel Rod Guide Assembly (2) into the horizontal slot as shown in the image above (A). Slide the Steel Guide Rod Assemblies so that both are aligned with each other and the holes are facing in the same direction (A). Insert the Steel Rod & Pencil Holder through the two Steel Rod Guide Assembly's (B).

6. Position the Pencil Holder (Minor)

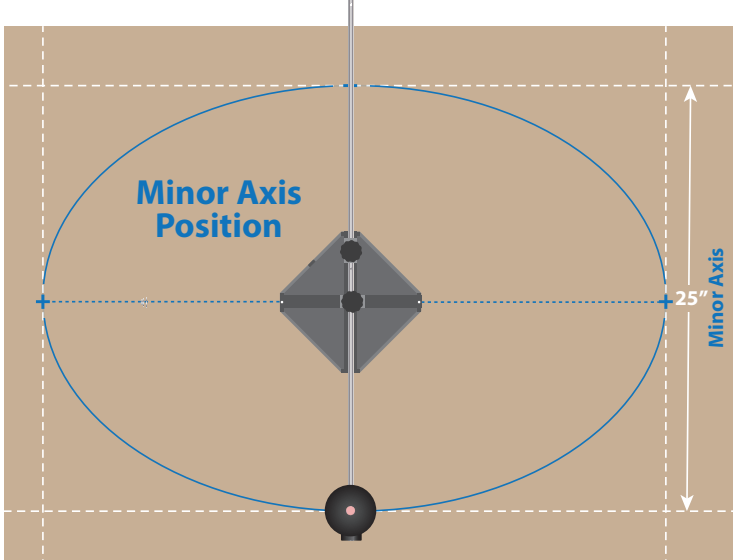

Rotate the Rod and Pencil Holder to the Minor Axis. Adjust the rod so that the pencil point is aligned with the mark that was made for the Minor Axis. Secure the Minor Axis Knob (the knob in the center) to the Steel Rod.

8. Draw The Ellipse

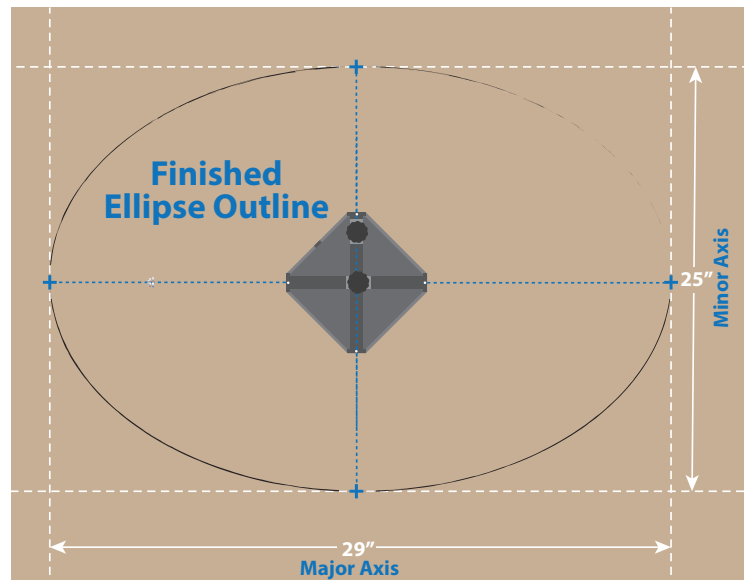

With a pencil installed into the Pencil Holder so that the tip of the pencil contacts the work piece, slowly draw the ellipse onto the workpiece by rotating the Pencil Holder around the jig. You may need to make a few passes around the jig for the marking to appear clearly on your work piece.

7. Position the Pencil Holder (Major)

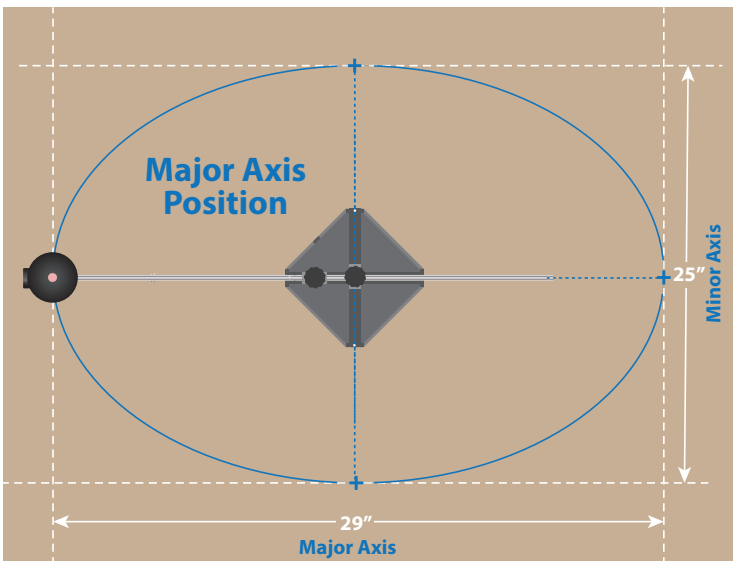

Rotate the Rod and Pencil Holder to the Major Axis. Adjust the rod so that the pencil point is aligned with the mark that was made for the Major Axis. Secure the Major Axis Knob (the knob in the center) to the Steel Rod.

9. Cut Pattern Out with a Jigsaw

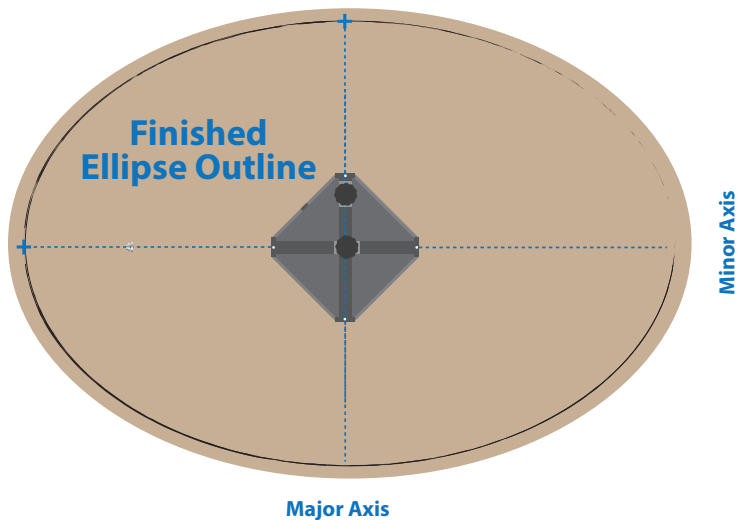

Remove the Rod and Pencil Holder from the Guide Assembly by loosening the two knobs on the guide assembly's. Once the rod and Pencil Holder is removed, use a jig saw or band saw and slowly cut off as much excess wood as possible. It is recommended that you stay about half the diameter of your router bit away from the edge of the ellipse. Doing this will help keep the load off of your router when making the initial passes with the router around the ellipse.

10. Insert Slide Rod Guides

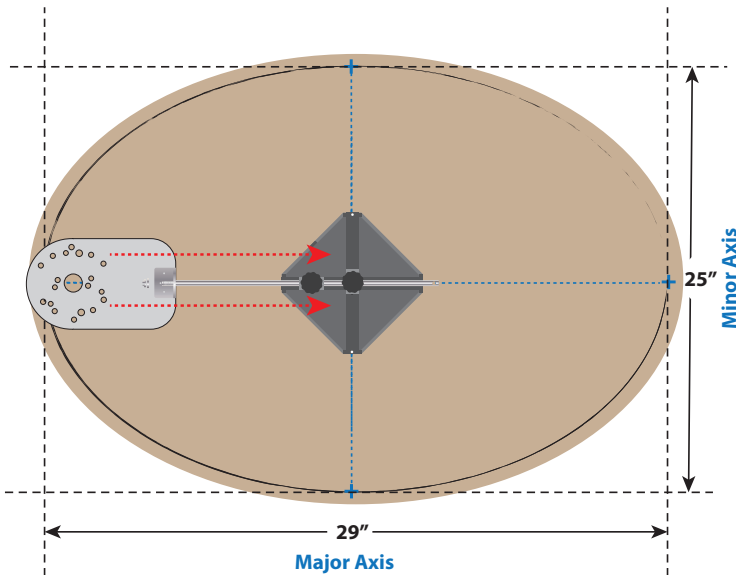

With your router mounted to the Router Base Plate and Rod Assembly instead of the Pencil Holder, **Repeat Step 5 (Insert Slide Rod Guides)**.

12. Position the Base (Major)

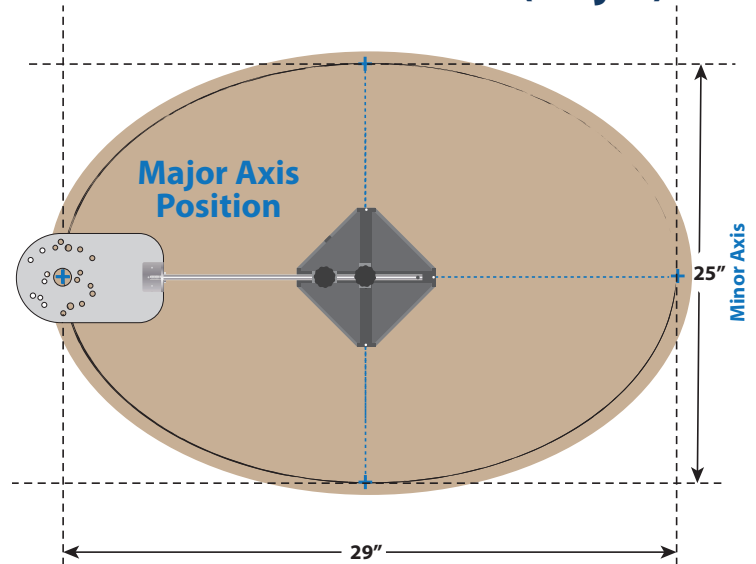

Rotate the Rod and Router Base Plate Assembly to the Major Axis. Adjust the base so that the edge of the bit is on the outside edge of your layout line. Secure the Major Axis Knob (the knob in the center) to the Steel Rod.

11. Position the Router Base (Minor)

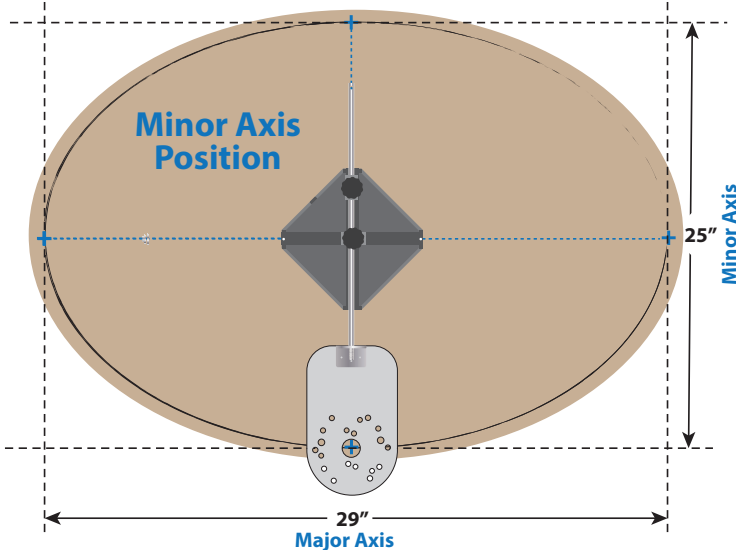

Rotate the Rod and Router Base Plate Assembly to the Minor Axis. Adjust the base so that the edge of the bit is on the outside edge of your layout line. Secure the Minor Axis Knob (the knob in the center) to the Steel Rod.

13. Make the Cut



With the power turned off, move the router around the ellipse before turning it on to be sure that its tracking properly. Plug in the router, turn it on and plunge the router so the bit cuts the full thickness of the board. Slowly work the router around the ellipse in the counter clockwise direction. Working the router in a counter clockwise direction keeps the router from pulling away from you while cutting. For thicker stock, you may need to make multiple depth cuts for best results.

HOW TO CUT CIRCLES

1. Insert One Guide Assembly

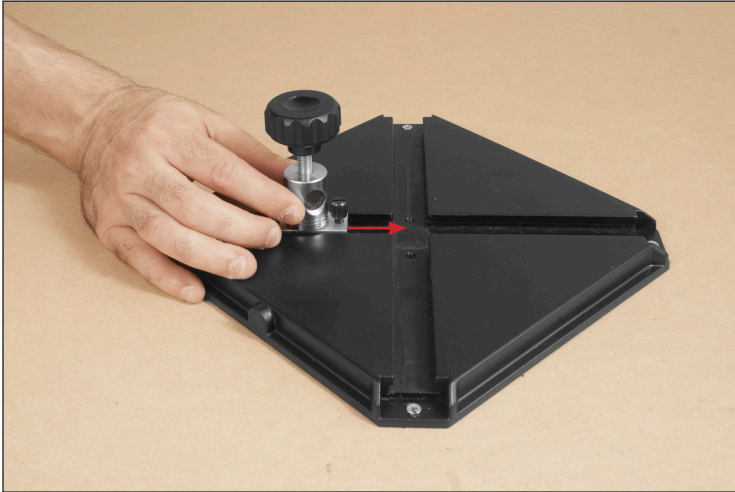

With the Ellipse Jig Base (1) centered and attached to the underside of your workpiece, insert one of the Steel Rod Guide Assembly's (2) into the center of the jig base.

3. Layout the Circle

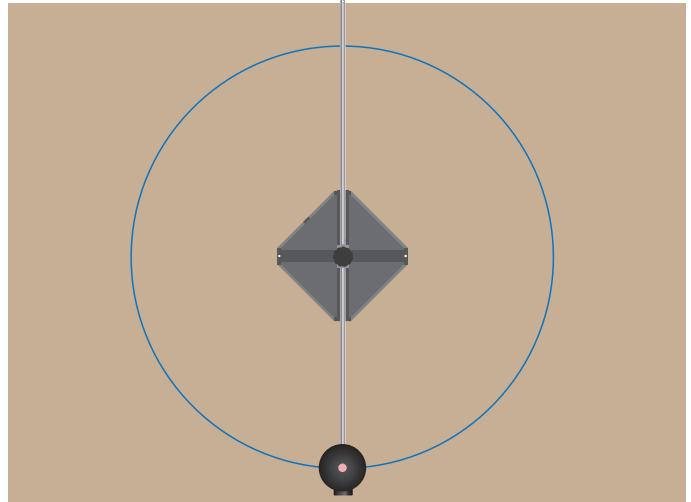

If you want your circle to be 36" in diameter you would need to measure 18" from the center of the base outward. With a pencil installed into the Pencil Holder so that the tip of the pencil contacts the work piece, slowly draw the circle onto the workpiece by rotating the Pencil Holder around the jig. You may need to make a few passes around the jig for the marking to appear clearly on your work piece. Remove the Rod and Pencil Holder after marking the work piece.

2. Secure Assembly and Insert Rod Assembly with Base Plate

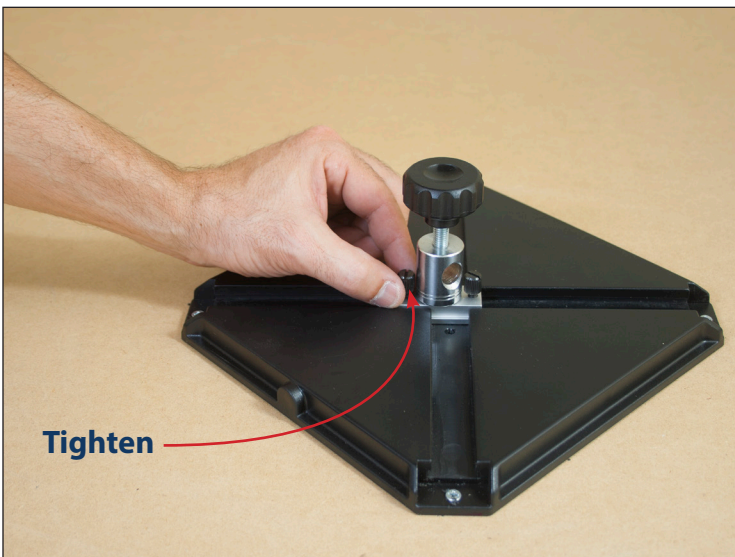

Using the two thumb screws, secure the Steel Rod Guide Assembly to the base by aligning it with two of the dimples in the center of the base. Slide the Steel Rod and Pencil Holder through the hole of the Steel Rod Guide. Adjust the Pencil Holder so it is at half the distance from the center of the jig base to the desired circle circumference. Secure the Knob Fixture.

4. Cut Pattern Out with a Jigsaw

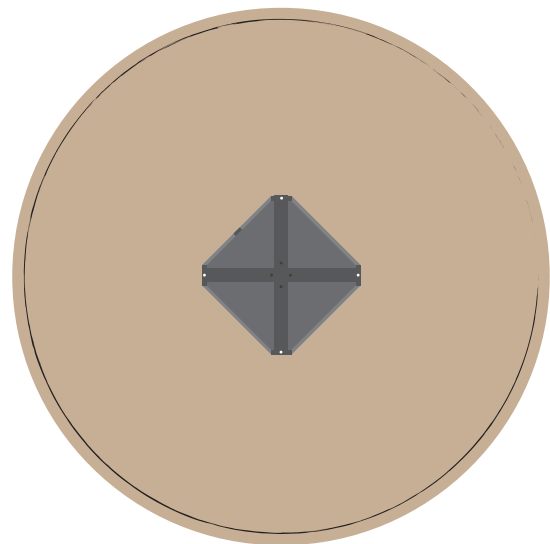

Using a jig saw or band saw and slowly cut off as much excess wood as possible. It is recommended that you stay about half the diameter of your router bit away from the edge of the circle. Doing this will help keep the load off of your router when making the initial passes with the router around the circle.

5. Install Rod & Router Base

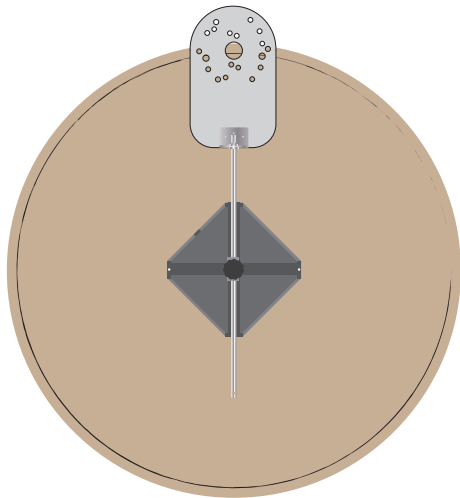

Once the circle has been cut to shape with a jigsaw, Install the Rod and Router Base Assembly with your router mounted to the Router Base. Adjust the base so that the edge of the bit is on the outside edge of your layout line. Secure the the Guide Rod Assembly Knob to the Steel Rod.

5. Make the Cut



With the power turned off, move the router around the circle before turning it on to be sure that its tracking properly. Plug in the router, turn it on and slowly plunge the router so the bit cuts the full thickness of the board. Slowly work the router around the circle in the counter clockwise direction. Working the router in a counter clockwise direction keeps the router from pulling away from you while cutting. For thicker stock, you may need to make multiple depth cuts for best results..

Finished Examples

Ellipse Finished

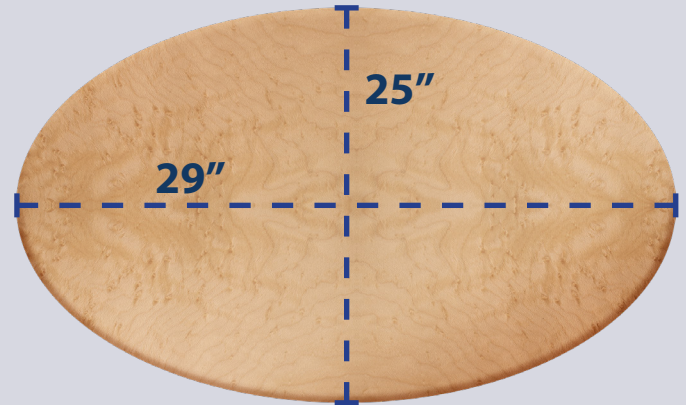

Circle Finished

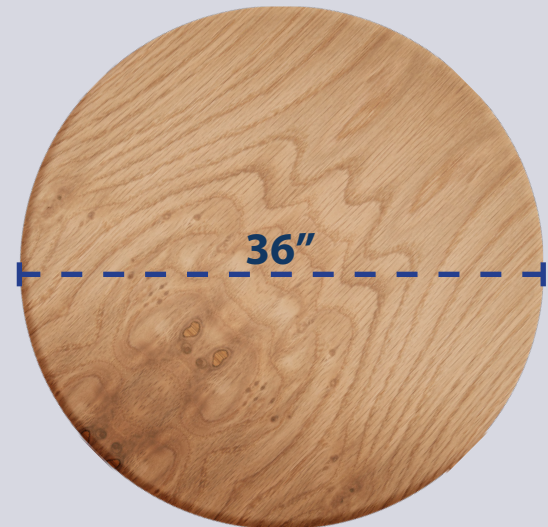

Optional Vacuum Base



The ellipse jig works with the Venturi Vacuum System (not included/sold separately)